

DUAL POWER OPERATIONAL AMPLIFIERS

- OUTPUT CURRENT TO 1A
- OPERATES AT LOW VOLTAGES
- SINGLE OR SPLIT SUPPLY
- LARGE COMMON-MODE AND DIFFERENTIAL MODE RANGE
- GROUND COMPATIBLE INPUTS
- LOW SATURATION VOLTAGE
- THERMAL SHUTDOWN

The L272 and L272M are monolithic integrated circuits in powerdip and minidip packages intended for use as power operational amplifiers in a wide range of applications including servo amplifiers and power supplies, compact disc, VCR, etc.

The high gain and high output power capability provide superior performance whatever an operational amplifier/power booster combination is required.

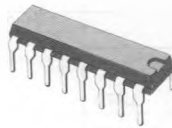

Powerdip (8 + 8)

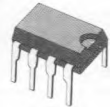

Minidip Plastic

ORDERING NUMBERS:

L272

L272M

ABSOLUTE MAXIMUM RATINGS

V_s	Supply voltage	28	V
V_i	Input voltage	V_s	
V_d	Differential input voltage	$\pm V_s$	
I_o	DC output current	1	A
I_p	Peak output current (non repetitive)	1.5	A
P_{tot}	Power dissipation at $T_{amb} = 80^\circ\text{C}$ (L272), $T_{amb} = 50^\circ\text{C}$ (L272M) $T_{case} = 75^\circ\text{C}$ (L272)	1	W
		5	W
T_{stg}, T_j	Storage and junction temperature	-40 to 150	$^\circ\text{C}$

BLOCK DIAGRAM

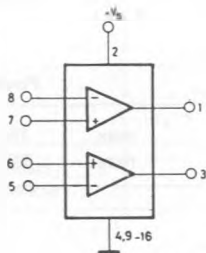

L272

5-5906.01

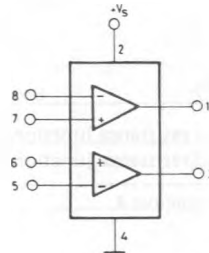

L272M

5-5929

CONNECTION DIAGRAM
(Top view)

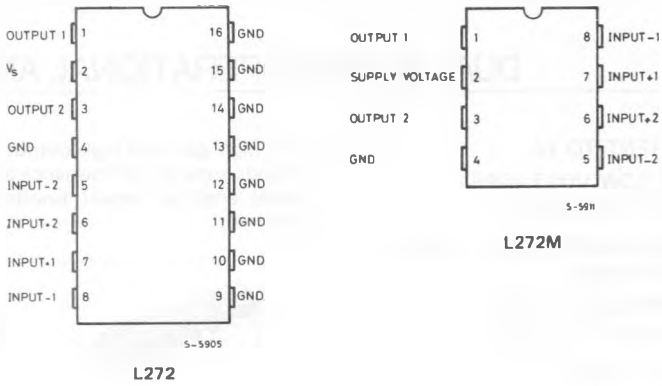

SCHEMATIC DIAGRAM (one only)

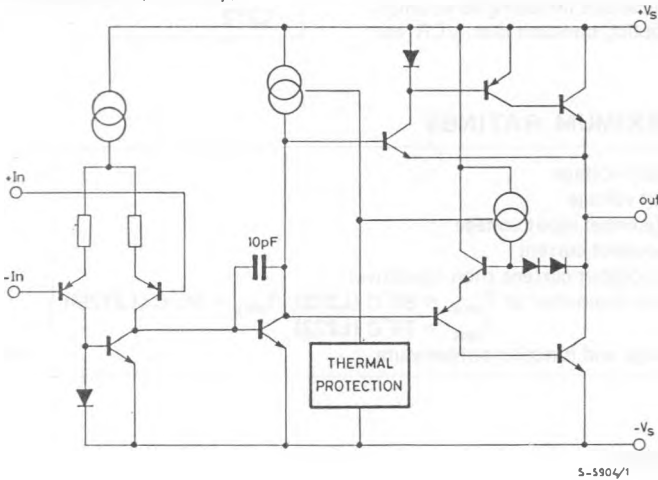

THERMAL DATA

THERMAL DATA			Powerdip	Minidip
$R_{th j-case}$	Thermal resistance junction-pins	max	15°C/W	* 70°C/W
$R_{th j-amb}$	Thermal resistance junction-ambient	max	70°C/W	100°C/W

* Thermal resistance junction-pin 4

ELECTRICAL CHARACTERISTICS ($V_s = 24V$, $T_{amb} = 25^\circ C$ unless otherwise specified)

Parameter	Test Conditions		Min.	Typ.	Max.	Unit
V_s Supply voltage			4		28	V
I_s Quiescent drain current	$V_o = \frac{V_s}{2}$	$V_s = 24V$		8	12	mA
		$V_s = 12V$		7.5	11	mA
I_b Input bias current				0.3	2.5	μA
V_{os} Input offset voltage				15	60	mV
I_{os} Input offset current				50	250	nA
SR Slew rate				1		V/ μs
B Gain-bandwidth product				350		KHz
R_i Input resistance			500			K Ω
G_v O.L. voltage gain	$f = 100Hz$		60	70		dB
	$f = 1KHz$			50		dB
e_N Input noise voltage	$B = 20KHz$			10		μV
I_N Input noise current	$B = 20KHz$			200		pA
CRR Common Mode rejection	$f = 1KHz$		60	75		dB
SVR Supply voltage rejection	$f = 100Hz$ $R_G = 10K\Omega$ $V_R = 0.5V$	$V_s = 24V$	54	70		dB
		$V_s = \pm 12V$		62		dB
		$V_s = \pm 6V$		56		dB
V_o Output voltage swing			21	23		V
				22.5		V
C_s Channel separation	$f = 1KHz$; $R_L = 10\Omega$; $G_v = 30dB$ $V_s = 24V$ $V_s = \pm 6V$			60	60	dB
d Distortion	$f = 1KHz$ $V_t = 24V$			$G_v = 30dB$ $R_L = \infty$	0.5	%
T_{sd} Thermal shutdown junction temperature				145		$^\circ C$

Fig. 1 - Quiescent current vs. supply voltage

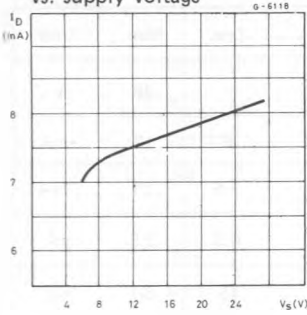

Fig. 2 -- Quiescent drain current vs. temperature

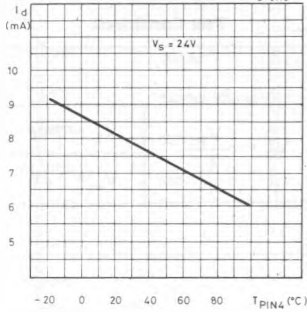

Fig. 3 - Open loop voltage gain

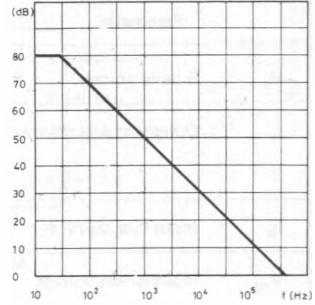

Fig. 4 - Output voltage swing vs. load current

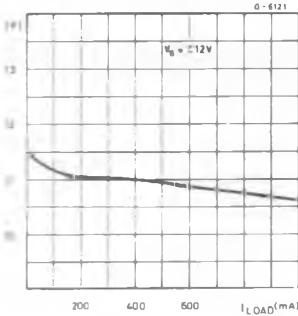

Fig. 5 -- Output voltage swing vs. load current

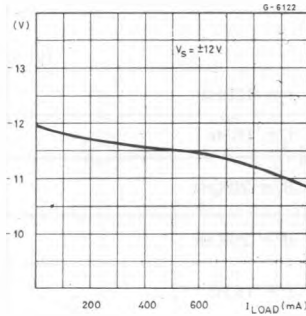

Fig. 6 - Supply voltage rejection vs. frequency

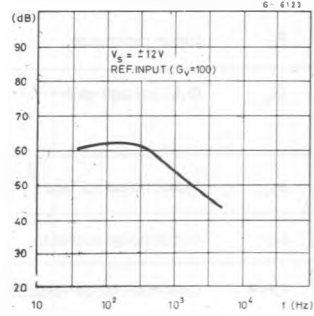

Fig. 7 - Channel separation vs. frequency

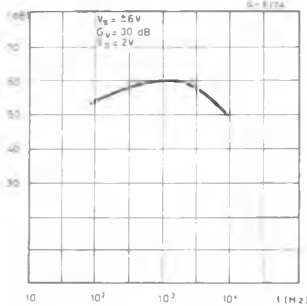
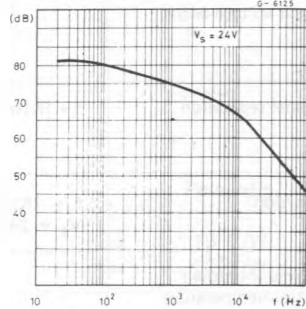

Fig. 8 -- Common mode rejection vs. frequency



APPLICATION SUGGESTION

NOTE

In order to avoid possible instability occurring into final stage the usual suggestions for the linear power stages are useful, as for instance:

- layout accuracy;

- A 100nF capacitor connected between supply pins and ground;
- boucherot cell (0.1 to 0.2 μ F + 1 Ω series) between outputs and ground or across the load.

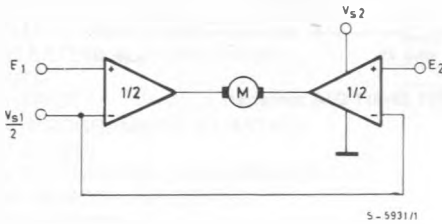
Fig. 9 - Bidirectional DC motor control with μ P compatible inputs

V_{S1} = logic supply voltage
Must be $V_{S2} > V_{S1}$
E1, E2 = logic inputs

Fig. 10 - Servocontrol for compact-disc

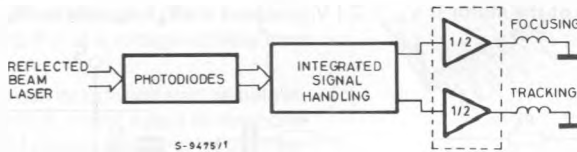

Fig. 11 - Capstan motor control in video recorders

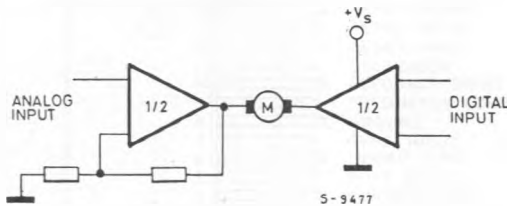
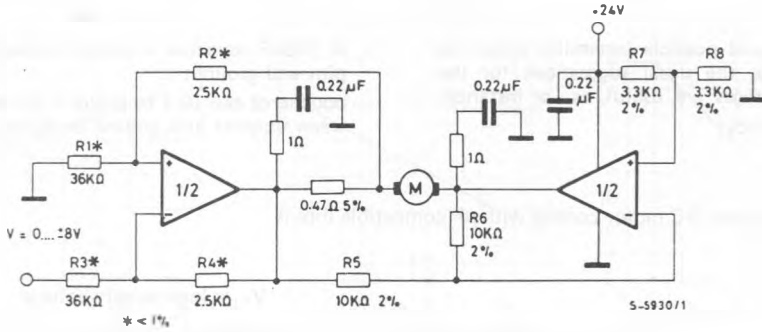

Fig. 12 - Motor current control circuit



Note: The input voltage level is compatible with L291 (5-BIT D/A converter)

Fig. 13 - Bidirectional speed control of DC motors.

For circuit stability ensure that $R_x > \frac{2R_3 \cdot R_1}{R_M}$ where R_M = internal resistance of motor. The voltage available at the terminals of the motor is $V_M = 2 \left(V_1 - \frac{V_s}{2} \right) + |R_o| \cdot I_M$ where $|R_o| = \frac{2R_3 \cdot R_1}{R_x}$ and I_M is the motor current.

